

MOKA 摩卡

工业机器人

Industrial Robot Series

Industrial
Robot
Series

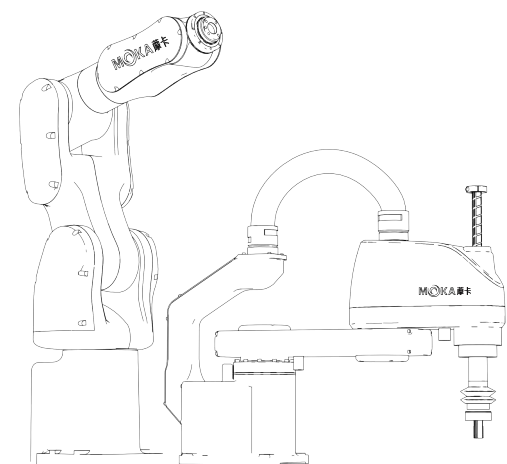

Higher Precision
更高精度



Higher Protection Level(IP67)
更高防护等级 (IP67)



Higher Speed
更高速度



Better Price Performance
更高性价比

V8.2

摩卡机器人全球化战略布局图

GLOBALIZATION MARKET LAYOUT

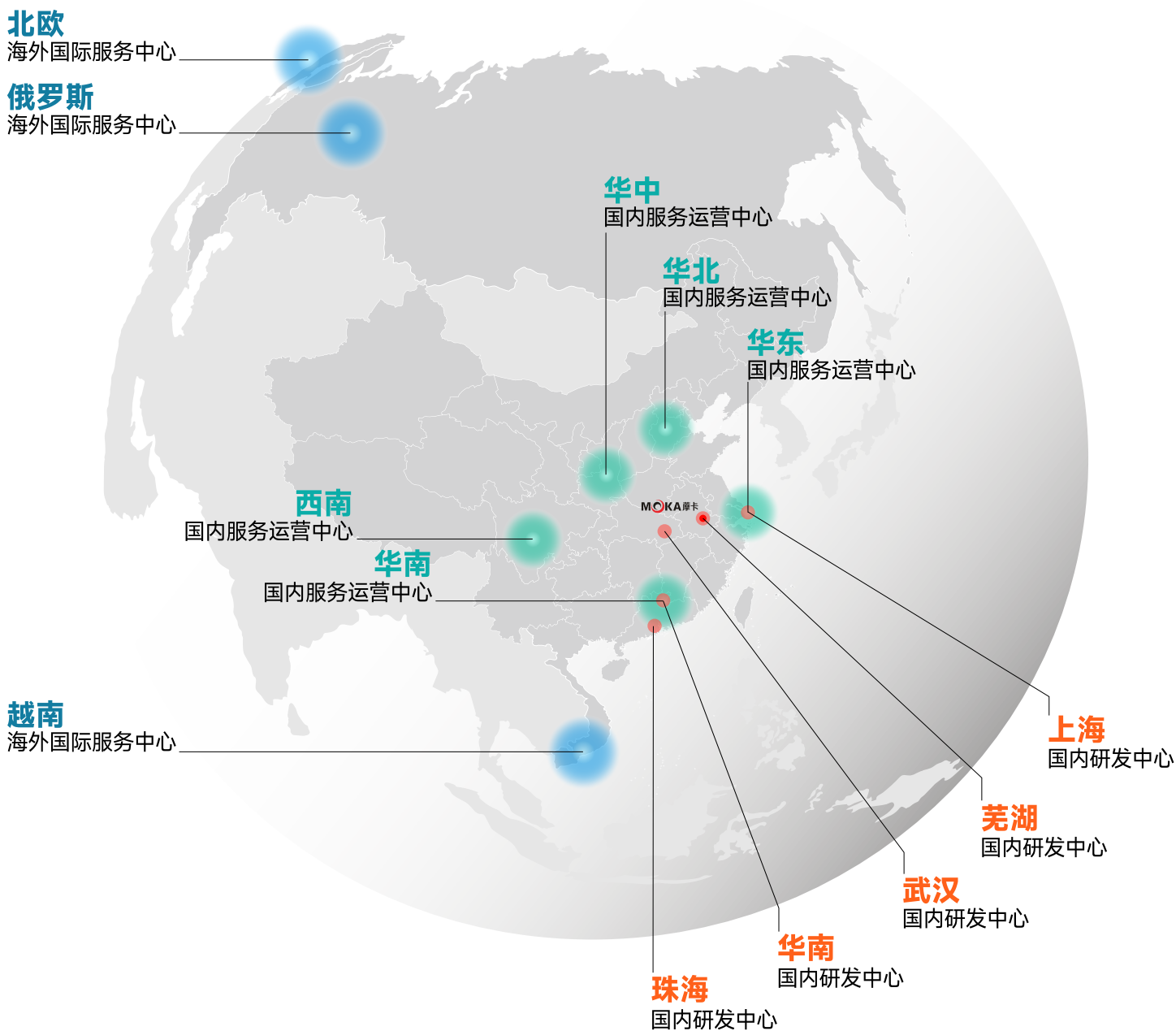



摩卡机器人科技有限公司是一家专业从事于工业机器人本体研发、生产制造、销售为一体的公司，目前拥有20余款系列工业机器人产品。公司依托10余年机器人研发技术优势和自身强大的细分市场高效定制能力，于2023年先后成立了“五大事业部”、“五大国内运营服务中心”和“三大海外国际技术服务中心”，在全面布局全球化战略的同时，深耕国内细分市场。摩卡机器人致力于将机器人自动化技术应用到各行各业，并以“引领新一代机器人自动化革命”为公司使命，始终践行“速度至上，精准为王”的产品理念，打造超高精度、超高速度、超高性价比的机器人本体。

荣誉资质

Honorary qualifications

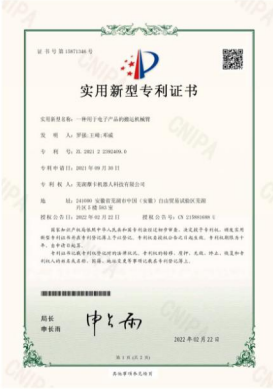
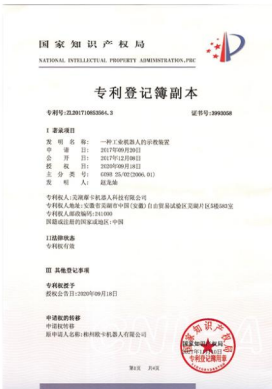

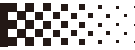

MB04SC-300



MB04SC-400



MB10SC-500



MB10SC-600



MB10SC-700



MB25SC-800



MB25SC-900

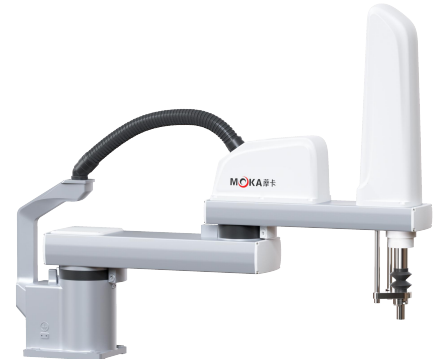

MB25SC-1000

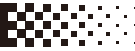

MB04S-580



MB10S-740



MB10S-920



MB20-2100



MB35-1870



MB45-1870



MB180-3200



MB210-2650



MB280-2650



MR10C-1488



MR30C-1750



MR10W-1440-D



MR12-2010



MR12Z-1550



MR80E-2250



MR60E-2680

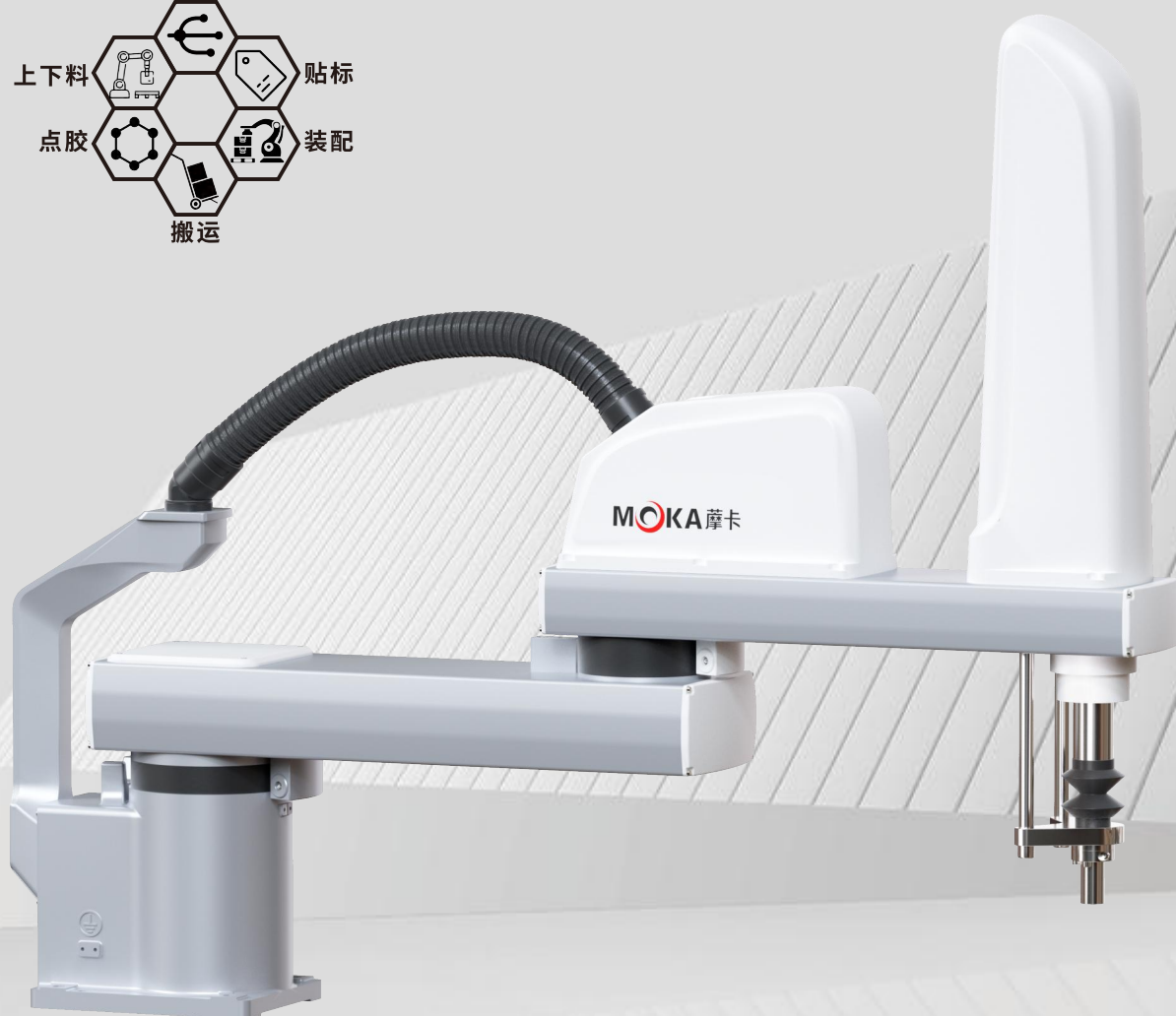
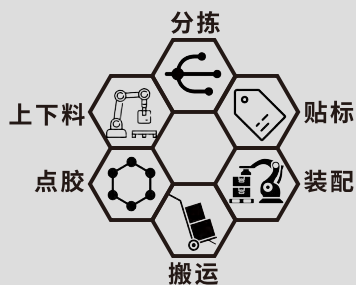

轴数	Axis	4轴	运动参数	Moving range&speed	
运动半径	Motion radius	1000mm	1轴S	J1+J2合成速度 11520mm/s	运动范围±135°
电源容量	Power capacity	3.0KVA	2轴L		运动范围±150°
有效载荷	Payload	额定10KG/最大25KG	3轴U	运动速度2020mm/s	运动范围420mm
重复定位精度	Repeatability	±0.025mm	4轴R	运动速度720°/s	运动范围±360°
机器人重量	Robot mass	66KG	输入/输出信号	Signals	标配16进/16出24VDC
内置气管	Power capacity	Φ8	安装方式	Install	落地式

安装环境

温度	0-45°C	湿度	20~80%RH(无结露)	无引火性、腐蚀性气体、液体、无溅水	少油、粉尘
振动加速度	4.9M/S ² (0.5G)以下	海拔	1000M以下	远离电磁源	远离磁场

控制柜参数

外形尺寸	Overall dimension	420 (宽) * 450 (深) * 200 (高) MM (含突起物)
概略质量	Rough quality	18.5KG
冷却方式	Cooling method	直接冷却
电源规格	Power specifications	单相220V 50/60HZ
接地	Grounding	工业接地 (接地电阻100Ω以下专用接地)
输入输出信号	Input/Output signal	通用信号: 输入16, 输出16 (16进16出)
位置控制方式	Position control method	串行通信方式EtherCAT.TCP/IP
内存容量	Memory capacity	JOB: 200000步, 10000机器人命令 (共200M)
LAN(上位连接)	LAN(Host link)	Ethercat (1个) TCP/IP (1个)
控制方式	Control mode	软件伺服<位置控制>
周围温度	Ambient temperature	通电时: 0~ + 45°C, 保管时: - 20~ + 60°C
驱动单元	Driver unit	AC伺服用伺服包 (共4轴)
相对湿度	Relative humidity	10%~90% (不结露)
振动	Vibrate	0.5G以下

串口I/F	Serial port I/F	RS485 (一个) RS422 (一个) RS232 (一个) CAN接口 (一个) USB接口 (一个)
海拔	Altitude	海拔1000m以下, 超过1000m, 每增加100m最大周围温度降低1%, 最高可在2000m使用
其它	Other	无粉尘、切屑液 (含冷却液)、有机溶液、油烟、水、盐分、药品、防锈油、无强微波、紫外线、X射线、放射线照射

示教编程器规格

外形尺寸	Overall dimensions	280 (宽) * 220 (深) * 120 (高) mm (含突起物)
毛重	gross weight	0.6KG
材质	material quality	强化塑料
显示屏	display screen	8英寸彩色LED、触摸屏640*480像素
防护等级	protection grade	IP54
电缆长度	Cable Length	标配: 5m; 选配: 15m

操作机	manipulator	选择键、轴操作键、数值/应用键、带钥匙的切换模式键/ (示教模式、再现模式、远程模式)、急停键、始能键、USB端口1个
-----	-------------	---



安全注意

使用前请熟读说明书及附属文件等,正确使用。

·此目录记载的产品为MB25SC-1000

如 MB25SC-1000发生的故障以及错误及错误操作直接威胁到人身安全,或被使用于危害人体安全的用途时请与我们联系,我们将作出改善。

·图解为意向图。

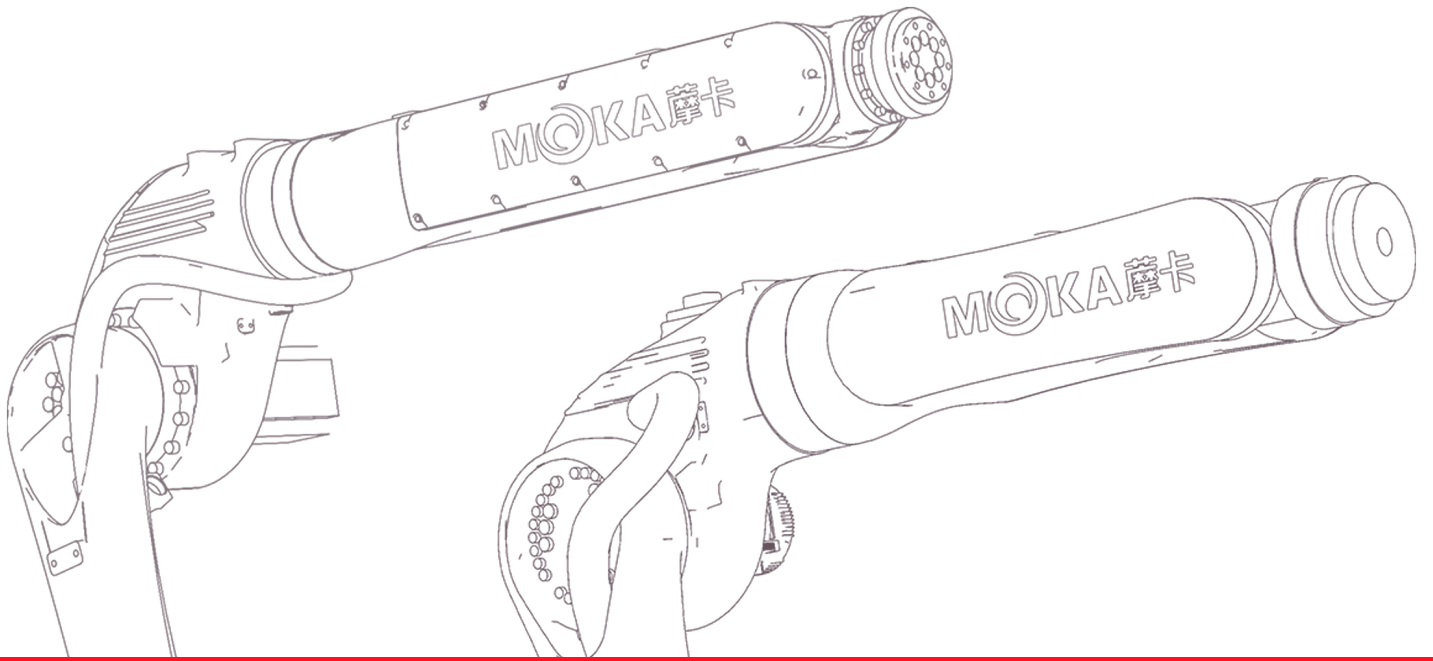

MOKA 摩卡

引领新一代机器人自动化革命



芜湖摩卡机器人科技有限公司
WUHU MOKA ROBOT TECHNOLOGY CO.,LTD
地址:安徽省芜湖市鸠江区纬四路19号
NO.19,Wei 4th Road,JiuJiang District,Wuhu City,Anhui Province

官方网址:www.moka-robot.com
企业邮箱:moka@moka-robot.com
全国热线:400-800-5282